

Rev_00 2024



 Agripower

EY-42TCS

Technical Data Sheet

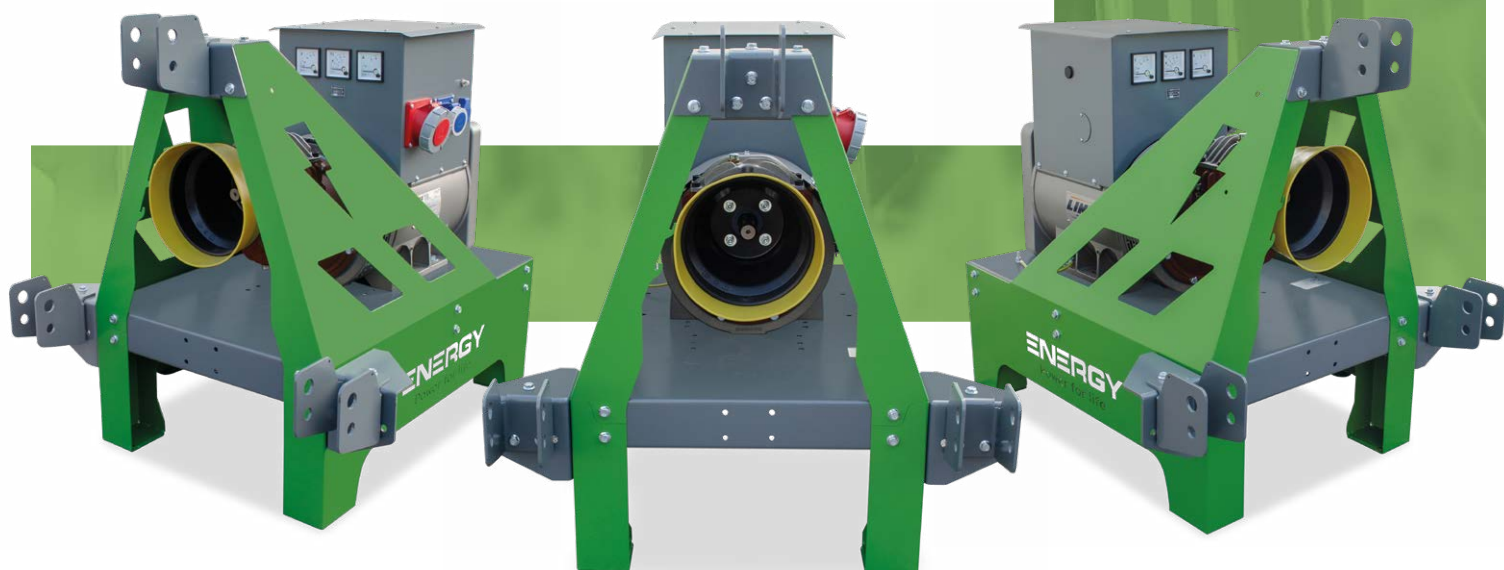

L'immagine è puramente a titolo dimostrativo
Image for demonstration purpose only

MADE IN ITALY

EY-42TCS - Technical Data Sheet

DATI TECNICI - TECHNICAL DETAILS

GENERALI - GENERAL

Potenza in continuo - Prime power PRP	kVA / kW	42 / 33,6
Potenza in emergenza - Stand-by power LTP	kVA / kW	46,2 / 37
Tensione - Voltage	V	400/230
Fattore di potenza - Power factor	Cosφ	0,8
Frequenza - Frequency	Hz	50
Giri/mn alternatore - Alternator Rpm		1500
Amperaggio nominale - Ampere rating	A	60,6
Taglia interruttore magnetotermico generale - General Circuit Breaker size	A	63
Potenza trattore necessaria - Tractor power needed	Hp	80

CONDIZIONI AMBIENTALI DI RIFERIMENTO - ENVIRONMENTAL REFERENCE CONDITIONS

Temperatura - Temperature: **40° C** - Altitudine - Height: **1000 mslm** - Umidità - Humidity: **60,00%**

MOLTIPLICATORE - GEARBOX

Marca - Brand	COMER
Modello - Model	9.624.344.10
Giri in entrata al moltiplicatore - Input rpm in the gearbox	rpm 430
Rapporto moltiplicatore - Gearbox ratio	1 : 3,5
Capacità olio moltiplicatore - Gearbox oil capacity	lt 0,5
Temperatura massima olio - Max oil temperature	°C 110
Albero PTO - PTO shaft	1"3/8 Z6

CURVA DI DECLASSAMENTO - DERATING CURVES

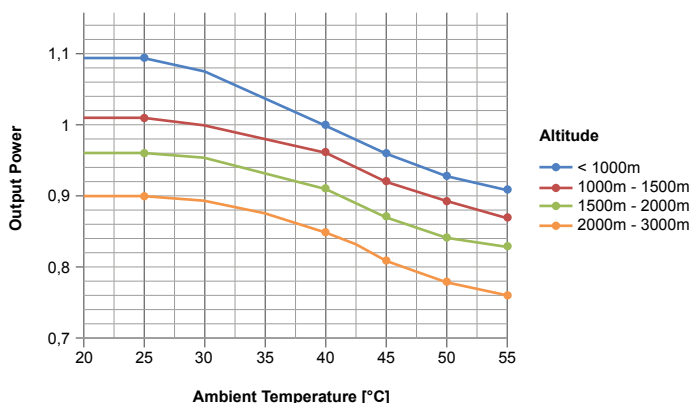

ALTERNATORE - ALTERNATOR

Marca - Brand	LINZ
Modello - Model	PRO18M E/4
N. di poli - Number of poles	4
N. di fasi - Phase number	3
Eccitazione - Excitation	Senza spazzole - Brushless
Regolazione della tensione - Voltage regulation	AVR
Grado di protezione - Protection degree	IP 23
Precisione della tensione - Voltage precision	± 1 %
Classe di isolamento - Insulation Class	H
Sistema di controllo - Control System	Autoeccitato - Self-excited
Velocità limite - Maximum Over speed	2250 rpm
Sovraccarico - Overload	110% della potenza nominale (max 1 h ogni 6 h di utilizzo) - 110% of rated power for 1 hr in a cycle of 6 hr
Portata d'aria richiesta - Air Flow Requirement	18 m³/min
Filtro Antidisturbo frequenze radio - R.F.I. Suppression	Standard EN55011
Modello AVR - AVR Model	HVR11
Rilevamento AVR - AVR Sensing	Monofase - Single-phase
Capacità di cortocircuito - Sustained Short Circuit	> 300% della potenza nominale - > 300% of rated current
Normative di riferimento - References	EN60034-1 ISO8528-3 EN55011
Efficienza in classe H - Efficiency in class H	89,3 % - 4/4 89,9 % - 3/4 86,3 % - 2/4 81,1 % - 1/4

CURVE DI EFFICIENZA @ 50 Hz - EFFICIENCY CURVES @ 50 Hz

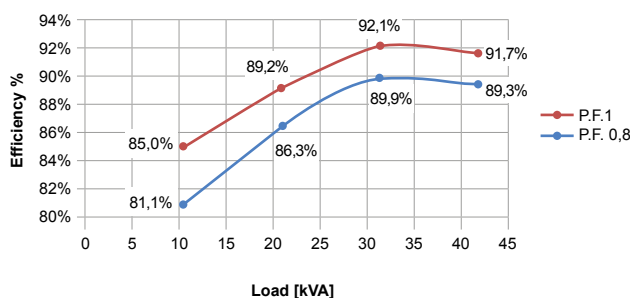

EY-42TCS - Technical Data Sheet

PESO E DIMENSIONI - WEIGHT AND DIMENSIONS

PESO - WEIGHT

Kg 325

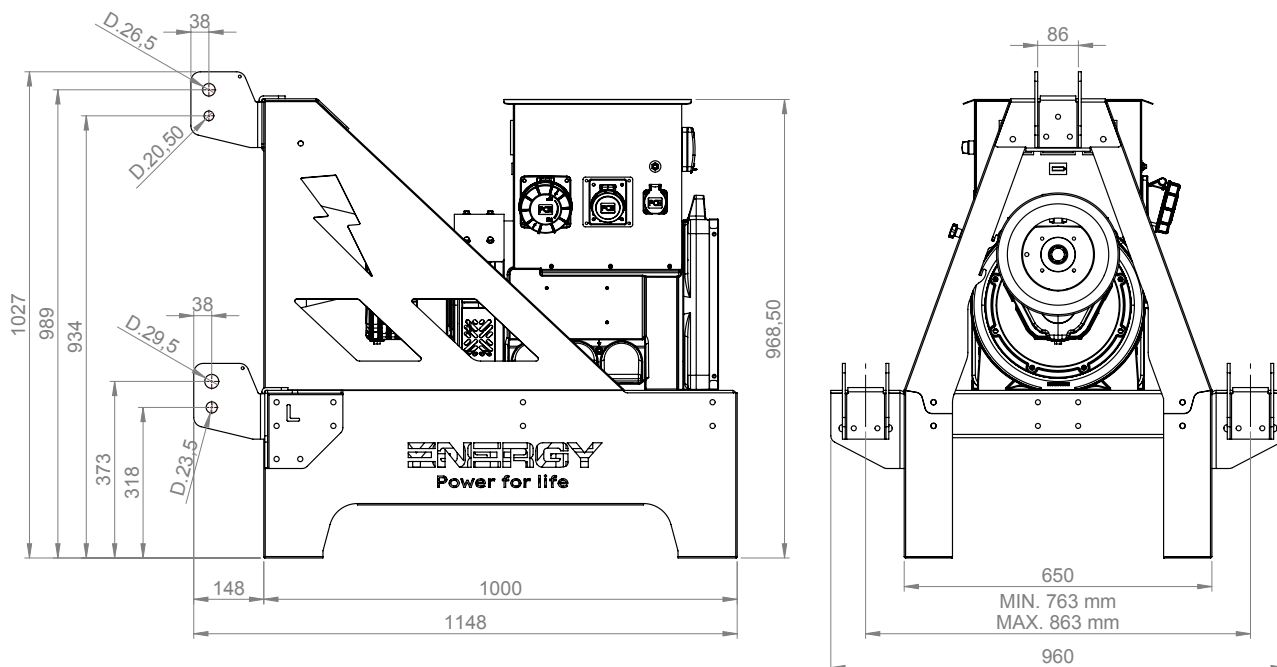

DOTAZIONE DI SERIE - STANDARD EQUIPMENT

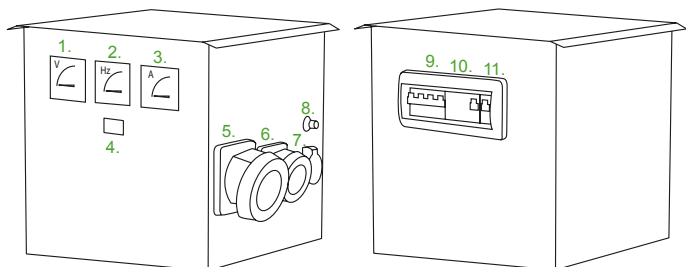

Quadro elettrico IP44 completo di:

1. Voltmetro 2. Frequenzimetro 3. Amperometro 4. Contatore
5. Presa CEE 400V 5poli 63A 6hr con (9.) interruttore magnetotermico 63A curva "C" e (10.) interruttore differenziale generale 63A classe A 30mA
6. Presa CEE 230V 3poli 16A con (11.) interruttore magnetotermico 16A curva "C"
7. Presa schuko 230V con (8.) breaker di protezione 16A

IP44 electric panel complete with:

1. Voltmeter 2. Frequencymeter 3. Ammeter 4. Hours counter
5. CEE socket 400V 5poles 63A 6hr with (9.) Magnetothermal switch 63A curve "C" and (10.) general differential breaker 63A class A 30mA
6. CEE socket 230V 3poles 16A with (11.) Magnetothermal switch 16A curve "C"
7. Schuko socket 230V with (8.) thermic breaker 16A

Il quadro elettrico è configurabile secondo le esigenze del cliente.

The electrical panel can be configurable according to the customer's requirements.

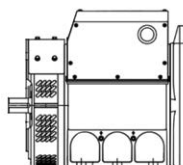

Alternatore trifase

Three-phase alternator

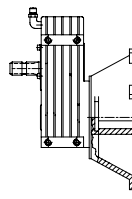

Moltiplicatore di giri con cuffia di protezione

Gearbox with protection cup

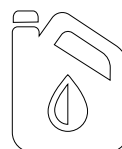

Olio di primo riempimento nel moltiplicatore

Oil of first filling into the gearbox

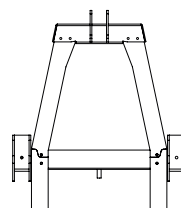

Basamento con attacco a 3 punti

Base frame with 3 fixing points

EY-42TCS - Technical Data Sheet

OPTIONAL ELETTRICI - ELECTRICAL OPTIONAL

OPT-AGR-001 - Quadro ISO EASY - ISO EASY panel

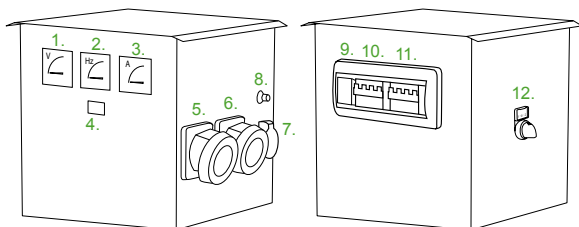

1. Voltmetro 2. Frequenzimetro 3. Amperometro 4. Contaore
5. (lato casa) Presa CEE 400V 5poli 63A 1hr o 7hr con (10.) interruttore magnetotermico 63A curva "C" e bobina di sgancio
6. (lato campo) Presa CEE 400V 5poli 63A 6hr con (11.) interruttore magnetotermico 63A curva "C" e bobina di sgancio
7. (lato campo) Presa schuko 230V con (8.) breaker di protezione 16A
9. Isolatore di controllo 12. Selettore manuale 1/0/2 (casa/campo)

1. Voltmeter 2. Frequency meter 3. Ammeter 4. Hours counter
5. (house side) CEE socket 400V 5poles 63A 1hr or 7hr with (10.) Magnetothermic switch 63A curve "C" and release coil
6. (field side) CEE socket 400V 5poles 63A 6hr with (11.) Magnetothermic switch 63A curve "C" and release coil
7. (field side) Schuko socket 230V with (8.) protection breaker 16A
9. Isolator control 12. Manual selector 1/0/2 (house/field)

OPT-AGR-002 - Quadro ISO FULL - ISO FULL panel

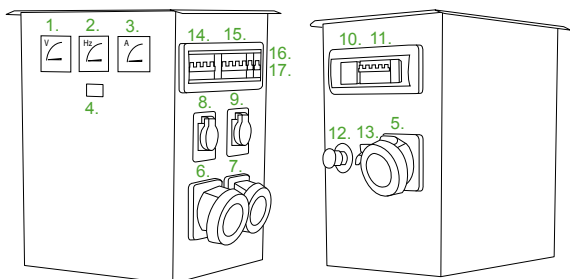

1. Voltmetro 2. Frequenzimetro 3. Amperometro 4. Contaore
5. (lato casa) Presa CEE 400V 5poli 63A 1hr o 7hr con (11.) interruttore magnetotermico 63A curva "C" e bobina di sgancio
6. (lato campo) Presa CEE 400V 5poli 63A 6hr con (14.) interruttore magnetotermico 63A curva "C" e bobina di sgancio
7. (lato campo) Presa CEE 400V 5poli 32A 6hr con (15.) interruttore magnetotermico 32A curva "C"
8. (lato campo) Presa schuko 230V con (16.) interruttore magnetotermico 16A curva "C"
9. (lato campo) Presa schuko 230V con (17.) interruttore magnetotermico 16A curva "C"
10. Isolatore di controllo 12. Pulsante arresto d'emergenza
13. Selettore manuale 1/0/2 (casa/campo)

1. Voltmeter 2. Frequency meter 3. Ammeter 4. Hours counter
5. (house side) CEE socket 400V 5poles 63A 1hr or 7hr with (11.) Magnetothermic switch 63A curve "C" and release coil
6. (field side) CEE socket 400V 5poles 63A 6hr with (14.) Magnetothermic switch 63A curve "C" and release coil
7. (field side) CEE socket 400V 5poles 32A 6hr with (15.) Magnetothermic switch 32A curve "C"
8. (field side) Schuko socket 230V with (16.) Magnetothermic switch 16A curve "C"
9. (field side) Schuko socket 230V with (17.) Magnetothermic switch 16A curve "C"
10. Isolator control 12. Emergency stop button
13. Manual selector 1/0/2 (house/field)



OPT-AGR-003

Regolatore Elettronico di tensione con rilevamento trifase (AVR) Precisione +-1%.

Automatic Voltage Regulator with three-phase sensing (AVR) Accuracy +-1%.



OPT-AGR-004

Strumento di protezione per bassa/alta tensione e frequenza.

Low/high voltage and frequency protection device.



OPT-AGR-005

Commutatore manuale di linea 1, 0, 2 (RETE / 0 / GENERATORE).

Manual transfer switch (MTS) 1, 0, 2 (MAINS / 0 / GENERATOR).



OPT-AGR-014 / OPT-AGR-015 / OPT-AGR-016

Quadro distribuzione 16/32/63amp.

Distribution panel 16/32/63amp.



OPT-AGR-017

Spine CEE 16A/32A/63A/125A.

CEE Plug 16A/32A/63A/125A.



EY-42TCS - Technical Data Sheet

OPTIONAL MECCANICI - MECHANICS OPTIONAL



OPT-AGR-006

Kit filtri IP44 per alternatore (aspirazione ed espulsione) con panno filtrante sostituibile.

IP44 filters kit for alternator (intake and expulsion) with replaceable filter element.

3 x



OPT-AGR-007

Kit ganci 3 punti per trattori categoria I o II:
2 x agganci per i punti inferiori compresi di spina a scatto con catenella + 1 x aggancio per il punto superiore completo di spina a scatto con catenella.

Kit 3 points pins for tractors cat. I or cat.II:
2 x low points complete with snap pin with chain + 1 x top point complete with snap pin with chain.



OPT-AGR-008

Kit barre protezione.

Extra protection bars.



OPT-AGR-009

Kit ruote per movimentazione manuale.

Kit wheels for manual movements.



OPT-AGR-010

Kit carrello per traino.

Kit trailer for ground movements.



OPT-AGR-011

Kit porta cardano.

Cardan holder kit.



OPT-AGR-012

Picchetto terra: 1 x picchetto di terra sp. 5mm lunghezza 1mt + morsetto terminale doppio + 2mt di cavo.

Earthing rod 1mt length: 1 x earthing rod 5mm thickness, complete with double clamp and 2mt of cable.



OPT-AGR-013

Customizzazione del basamento.

Customization of the base frame.

COMPONENTI SELEZIONATI - SELECTED COMPONENTS

